

Plastic Modular Belt

Series **uni Light** Type **C**

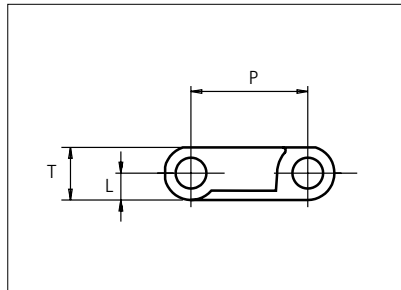

Straight running belt
 Nominal pitch: 19.1 mm (0.75 in)
 Surface type: Flat
 Surface opening: Closed
 Backflex radius: 25.0 mm (2.0 in)
 Pin diameter: \varnothing 5.0 mm (0.20 in)

Belt material & color	POM-LF BR	PP W G K	PP B	PA6 K		mm	in		mm	in	
Pin and lock material & color	PP W	PP W	PP B	PBT-GR N PP G		P (Nominal)	19.1	0.75	T	8.5	0.33
						L	4.3	0.17	-	-	-

Non standard material and color: See uni Material and Color Overview.

Alternative pin and lock materials: Pin: PE **W** PP **W** PA6.6 **N B** PBT **LG** SS304 PP **W** Lockpin: PBT **LG** PA6.6 **D N** PP **W B**

Belt width		Permissible tensile force (Belt/pin material)						Belt weight (Belt/pin material)						*Min. No. drive sprocket per shaft	Number of wear strips (Min. No.)	
		POM-LF/PP		PP/PP		PA6/PBT-GR		POM-LF/PP		PP/PP		PA6/PBT-GR			**Carry (pcs)	**Return (pcs)
mm	in	N	lbf	N	lbf	N	lbf	kg/m	lb/ft	kg/m	lb/ft	kg/m	lb/ft			
77	3.0	789	177	395	89	789	177	0.5	0.35	0.4	0.25	0.4	0.29	2	2	2
153	6.0	1572	353	786	177	1572	353	1.0	0.70	0.7	0.49	0.9	0.58	2	2	2
230	9.0	2355	529	1177	265	2355	529	1.6	1.05	1.1	0.74	1.3	0.86	2	2	2
306	12.1	3138	705	1569	353	3138	705	2.1	1.40	1.5	0.99	1.7	1.15	3	3	2
383	15.1	3921	881	1960	441	3921	881	2.6	1.75	1.8	1.23	2.1	1.44	3	3	2
459	18.1	4704	1057	2352	529	4704	1057	3.1	2.10	2.2	1.48	2.6	1.73	4	4	2
535	21.1	5486	1233	2743	617	5486	1233	3.6	2.45	2.6	1.73	3.0	2.01	4	4	2
612	24.1	6269	1409	3135	705	6269	1409	4.2	2.80	2.9	1.97	3.4	2.30	5	5	3
688	27.1	7052	1585	3526	793	7052	1585	4.7	3.14	3.3	2.22	3.9	2.59	5	5	3
764	30.1	7835	1761	3918	881	7835	1761	5.2	3.49	3.7	2.47	4.3	2.88	6	6	3
841	33.1	8618	1937	4309	969	8618	1937	5.7	3.84	4.0	2.71	4.7	3.16	6	6	3
917	36.1	9401	2113	4700	1057	9401	2113	6.2	4.19	4.4	2.96	5.1	3.45	7	7	4
994	39.1	10184	2289	5092	1145	10184	2289	6.8	4.54	4.8	3.20	5.6	3.74	7	7	4

Additional standard belt widths are available in steps of 76.4 mm (3.01 in.) Additional non-standard belt widths are available in steps of 19.1 mm (0.75 in.)

1910	75.2	19578	4401	9789	2201	19578	4401	13.0	8.73	9.2	6.16	10.7	7.19	13	13	7
------	------	-------	------	------	------	-------	------	------	------	-----	------	------	------	----	----	---

Additional standard belt widths are available in steps of 76.4 mm (3.01 in.) Additional non-standard belt widths are available in steps of 19.1 mm (0.75 in.)

2980	117.3	30545	6867	15273	3433	30545	6867	20.3	13.62	14.3	9.61	16.7	11.22	20	20	10
------	-------	-------	------	-------	------	-------	------	------	-------	------	------	------	-------	----	----	----

General belt tolerance is $\pm 0.4\%$ at 23°C/73°F and 50% RH. For exact belt width contact Customer Service. Non standard belt width on request.

The belt width in PA6 is 0.8 % wider than the belt width in the table

*Max. Load per Drive Sprocket. Belt material: POM-LF 1250 N (281 lbf), PP 700 N (157 lbf), PA6 1250 N (281 lbf)

**Max. Spacing between wear strips, Carry: 152 mm (6 in.) ; Return: 304 mm (12 in.)

Any questions? Please contact us.

Morskate Aandrijvingen BV
 Oosterveldsingel 47A
 7558 PJ Hengelo (Ov)
 The Netherlands

NL
 T +31 (0)74 - 760 11 11
 info@morskateaanrijvingen.nl
 www.morskateaanrijvingen.nl

DE
 T +49 692 - 222 34 95
 info@morskateantriebstechnik.de
 www.morskateantriebstechnik.de

EN
 T +31 (0)74 - 760 11 11
 info@morskatedrivetechnology.com
 www.morskatedrivetechnology.com

STANDARD

STRAIGHT RUNNING

PITCH 19.1 MM/0.75 IN

Accessories

Rubber Top

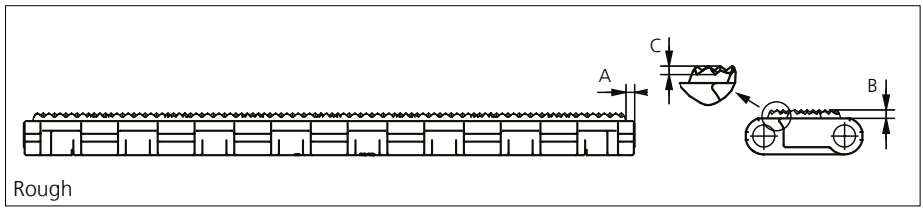
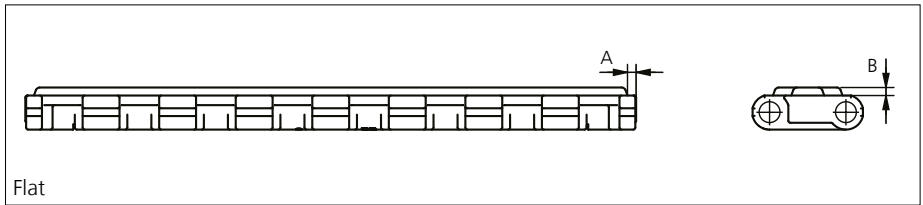

Type	Belt Material & color	Rubber Material & color	A		B		C		Link size	Width	
			mm	in	mm	in	mm	in		mm	in
Flat	PP K	03 K	2.0	0.08	2.0	0.08	1.0	0.04	K600	150.5	5.93
Rough											

Other Non Standard Rubber profiles: See uni Rubber Profile Overview.

Accessories

Flight

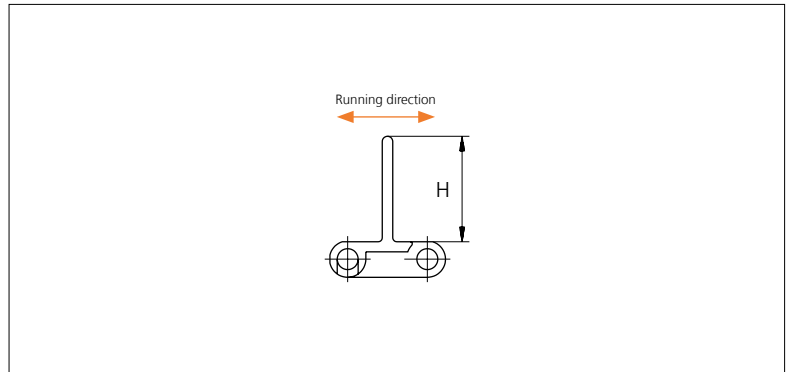
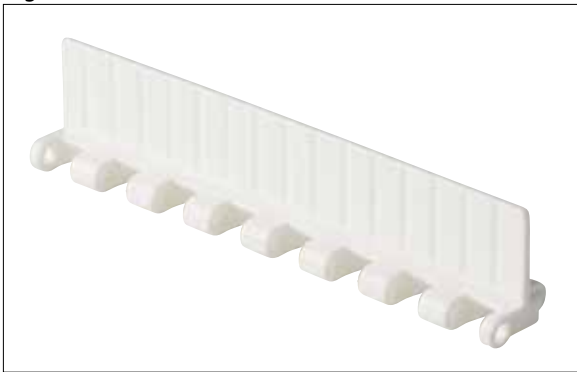

Type	Flight Material & color	H		Link size	Width		Indent	
		mm	in		mm	in	mm	in
Non Stick	PP-I W	25.4	1.00	K300	76.4	3.01	0.0	0.00
	PP-I W G							
	PA6 K 04 K							
Non Stick	PP-I W G PA6 K	25.4	1.00	K600	152.8	6.02	15.0	0.59
Non Stick/Support Ribs	PP-I W	25.4	1.00	K600	152.8	6.02	0.0	0.00
Non Stick/Support Ribs	PP-I W G PA6 K	50.8	2.00	K600	152.8	6.02	0.0	0.00
Non Stick/Support Ribs	PP-I G PA6 K	50.8	2.00	K600	152.8	6.02	15.0	0.59
Non Stick/Support Ribs	PP-I W G 04 K	76.2	3.00	K600	152.8	6.02	0.0	0.00
Non Stick/Support Ribs	PP-I W G	76.2	3.00	K600	152.8	6.02	15.0	0.59

Any questions? Please contact us.

Accessories

Side Guard

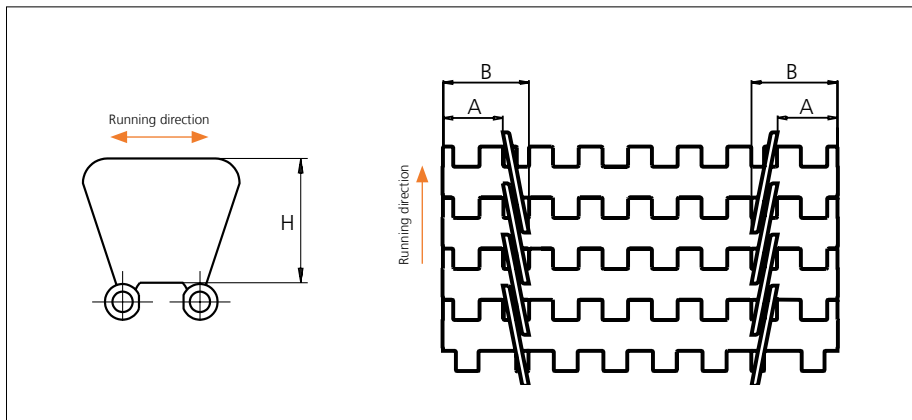

Type	Side Guard Material & color	H		A		B	
		mm	in	mm	in	mm	in
Closed	PP-I W G	31.4	1.24	15.0	0.59	25.0	0.98

Non Standard material and color: See uni Material and Color Overview.

Accessories

Tab

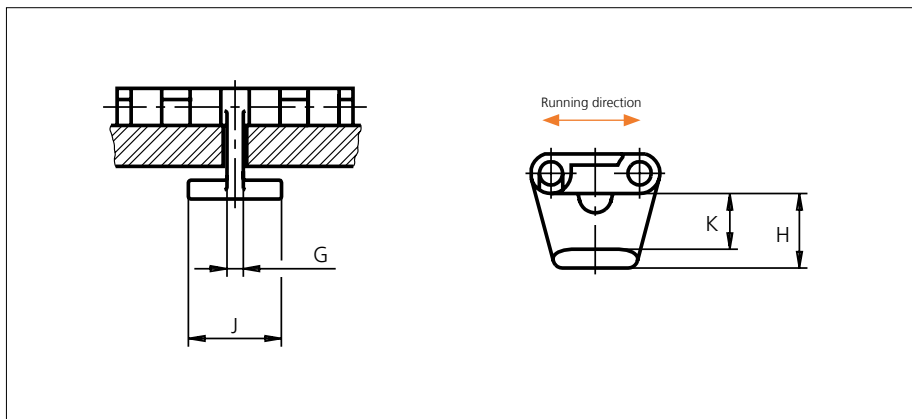

Type	Tab Material & color	G		J		K		H	
		mm	in	mm	in	mm	in	mm	in
Bottom Hold Down	POM-D W	3.5	0.14	20.0	0.79	11.7	0.46	15.9	0.63

Non Standard material and color: See uni Material and Color Overview.

Any questions? Please contact us.

Sprocket

No of teeth	Bore size													Overall diameter		Pitch diameter		Hub diameter		A-dimension		B-dimension		Single row/Two way	Double row/Two way	Molded PA6 LG	Machined PA6 
	Pilot bore	in	0.75	0.78	0.98	1.00	1.18	1.25	1.50	1.57	2.36	2.50	3.54														
	mm	19.1	20.0	25.0	25.4	30.0	31.8	38.1	40.0	60.0	63.5	90.0	mm	in	mm	in	mm	in	mm	in							
Z07	x	●	●										42.6	1.68	43.9	1.73	30.0	1.18	15.4	0.61	26.3	1.04	x		x		
Z10	x				●	●							61.7	2.43	61.6	2.43	45.0	1.77	25.0	0.98	35.2	1.39	x		x		
Z17	x			●	●	●	●	■	■				105.0	4.13	103.7	4.08	65.0	2.56	46.6	1.83	56.2	2.21	x		x		
Z24	x				●	●	●	■	■	●			147.2	5.80	146.0	5.75	70.0	2.76	68.0	2.68	77.3	3.04	x		x		
Z25	x					●	●	●	●	■	■		153.3	6.04	152.0	5.98	70.0	2.76	71.0	2.80	80.3	3.16	x		x		

■ Molded sprocket

● Molded sprocket

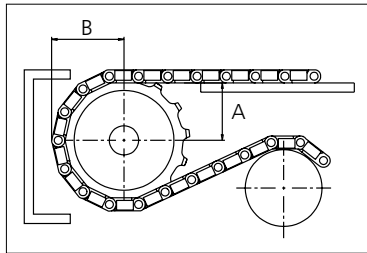
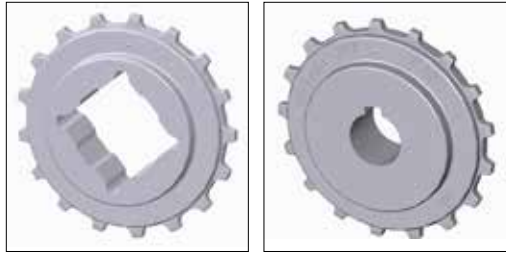

Other sprocket sizes are available upon request.
 Two-part sprocket are available upon request.
 Round bores are always delivered with keyway.
 Other bore sizes are available upon request.
 uni Retainer Rings: See uni Retainer Ring data sheet.
 Width of tooth = 4.8 mm (0.19 in)
 Width of sprocket = 25.0 mm (0.98 in)

Max load per sprocket shown does not take bore size into account.
 Please also ensure that sufficient size shaft is chosen for corresponding load.

For correct sprocket position: See uni Assembly Instructions for uni Light.
 For more detailed sprocket information, contact Customer Service.

Non standard material and color: See uni Material and Color Overview.

Any questions? Please contact us.

Morskate Aandrijvingen BV
 Oosterveldsingel 47A
 7558 PJ Hengelo (Ov)
 The Netherlands

NL
 T +31 (0)74 - 760 11 11
 info@morskateaandrijvingen.nl
 www.morskateaandrijvingen.nl

DE
 T +49 692 - 222 34 95
 info@morskateantriebstechnik.de
 www.morskateantriebstechnik.de

EN
 T +31 (0)74 - 760 11 11
 info@morskatedrivetechnology.com
 www.morskatedrivetechnology.com

Plastic Modular Belt

Series **uni Light** Type **Rough**

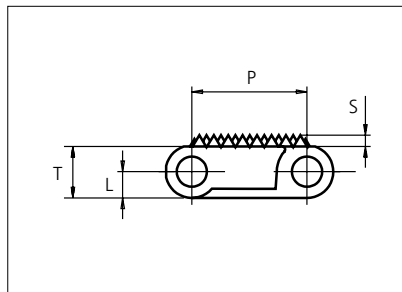

Straight running belt
 Nominal pitch: 19.1 mm (0.75 in)
 Surface type: Rough Top
 Surface opening: Closed
 Backflex radius: 25.0 mm (1.0 in)
 Pin diameter: \varnothing 5.0 mm (0.20 in)

Recommended Belt material & color	POM-D W		mm	in		mm	in
Recommended Pin material & color	PA6.6 N	P (Nominal)	19.1	0.75	T	8.5	0.33
		L	4.3	0.17	S	1.5	0.06

Non standard material and color: See uni Material and Color Overview.

Alternative pin and lock materials: Pin: PE **W** PP **W** PA6.6 **N** **B** PBT **LG** SS304 **W** Lockpin: PBT **LG** PA6.6 **D** **N** PP **W** **B**

Belt width		Permissible tensile force (Belt/pin material)						Belt weight (Belt/pin material)						*Min. No. drive sprocket per shaft	Number of wear strips (Min. No.)	
		POM-LF/PA6.6		PP/PA6.6		PA6/PBT-GR		POM-LF/PA6.6		PP/PA6.6		PA6/PBT-GR			**Carry (pcs)	**Return (pcs)
mm	in	N	lbf	N	lbf	N	lbf	kg/m	lb/ft	kg/m	lb/ft	kg/m	lb/ft			
77	3.0	789	177	395	89	789	177	0.5	0.35	0.4	0.25	0.4	0.29	2	2	2
153	6.0	1572	353	786	177	1572	353	1.0	0.70	0.7	0.49	0.9	0.58	2	2	2
230	9.0	2355	529	1177	265	2355	529	1.6	1.05	1.1	0.74	1.3	0.86	2	2	2
306	12.1	3138	705	1569	353	3138	705	2.1	1.40	1.5	0.99	1.7	1.15	3	3	2
383	15.1	3921	881	1960	441	3921	881	2.6	1.75	1.8	1.23	2.1	1.44	3	3	2
459	18.1	4704	1057	2352	529	4704	1057	3.1	2.10	2.2	1.48	2.6	1.73	4	4	2
535	21.1	5486	1233	2743	617	5486	1233	3.6	2.45	2.6	1.73	3.0	2.01	4	4	2
612	24.1	6269	1409	3135	705	6269	1409	4.2	2.80	2.9	1.97	3.4	2.30	5	5	3
688	27.1	7052	1585	3526	793	7052	1585	4.7	3.14	3.3	2.22	3.9	2.59	5	5	3
764	30.1	7835	1761	3918	881	7835	1761	5.2	3.49	3.7	2.47	4.3	2.88	6	6	3
841	33.1	8618	1937	4309	969	8618	1937	5.7	3.84	4.0	2.71	4.7	3.16	6	6	3
917	36.1	9401	2113	4700	1057	9401	2113	6.2	4.19	4.4	2.96	5.1	3.45	7	7	4
994	39.1	10184	2289	5092	1145	10184	2289	6.8	4.54	4.8	3.20	5.6	3.74	7	7	4

Additional standard belt widths are available in steps of 76.4 mm (3.01 in) Additional non-standard belt widths are available in steps of 19.1 mm (0.75 in)

1910	75.2	19578	4401	9789	2201	19578	4401	13.0	8.73	9.2	6.16	10.7	7.19	13	13	7
------	------	-------	------	------	------	-------	------	------	------	-----	------	------	------	----	----	---

Additional standard belt widths are available in steps of 76.4 mm (3.01 in) Additional non-standard belt widths are available in steps of 19.1 mm (0.75 in)

2980	117.3	30545	6867	15273	3433	30545	6867	20.3	13.62	14.3	9.61	16.7	11.22	20	20	10
------	-------	-------	------	-------	------	-------	------	------	-------	------	------	------	-------	----	----	----

General belt tolerance is +0/-0.4% at 23°C/73°F and 50% RH. For exact belt width contact Customer Service. Non standard belt width on request.

*Max. Load per Drive Sprocket. Belt material: POM-LF 1250 N (281 lbf), PP 700 N (157 lbf), PA6 1250 N (281 lbf)

**Max. Spacing between wear strips, Carry: 152 mm (6 in); Return: 304 mm (12 in)

= Single Link

NON STANDARD

STRAIGHT RUNNING

PITCH 19.1 MM/0.75 IN

Any questions? Please contact us.

Morskate Aandrijvingen BV
 Oosterveldsingel 47A
 7558 PJ Hengelo (Ov)
 The Netherlands

NL
 T +31 (0)74 - 760 11 11
 info@morskateaanrijvingen.nl
 www.morskateaanrijvingen.nl

DE
 T +49 692 - 222 34 95
 info@morskateantriebstechnik.de
 www.morskateantriebstechnik.de

EN
 T +31 (0)74 - 760 11 11
 info@morskatedrivetechnology.com
 www.morskatedrivetechnology.com

Accessories

Rubber Top

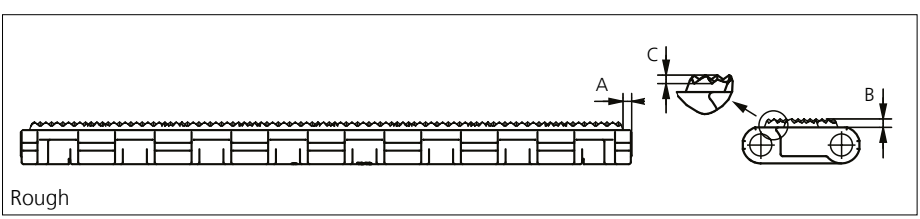
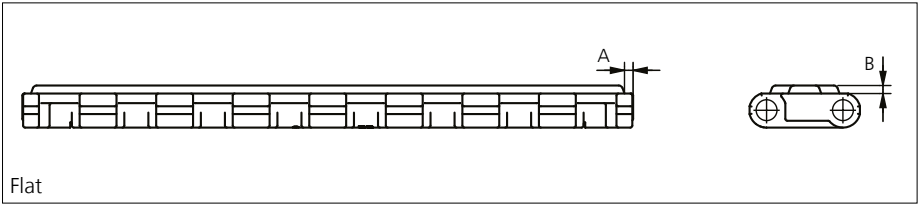

Type	Belt Material & color	Rubber Material & color	A		B		C		Link size	Width	
			mm	in	mm	in	mm	in		mm	in
Flat	PP K	03 K	2.0	0.08	2.0	0.08	1.0	0.04	K600	150.5	5.93
Rough											

Other Non Standard Rubber profiles: See uni Rubber Profile Overview.

Accessories

Flight

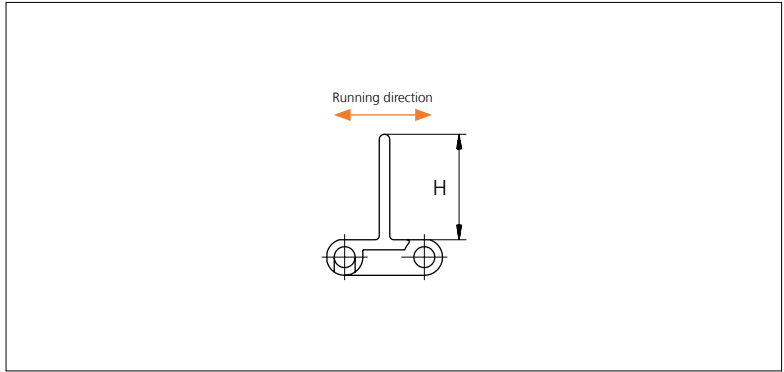
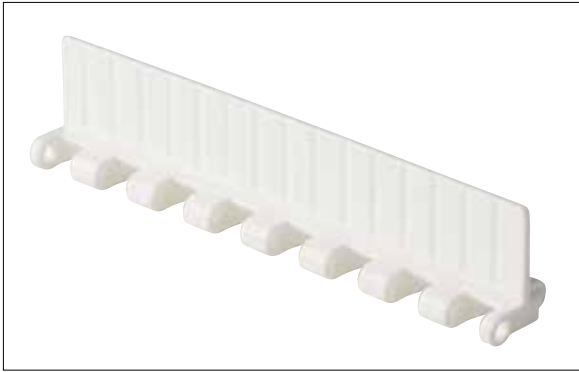

Type	Flight Material & color	H		Link size	Width		Indent	
		mm	in		mm	in	mm	in
Non Stick	PP-I W	25.4	1.00	K300	76.4	3.01	0.0	0.00
	PP-I W G							
	PA6 K 04 K							
Non Stick	PP-I W G PA6 K	25.4	1.00	K600	152.8	6.02	15.0	0.59
Non Stick/Support Ribs	PP-I W	25.4	1.00	K600	152.8	6.02	0.0	0.00
Non Stick/Support Ribs	PP-I W G PA6 K	50.8	2.00	K600	152.8	6.02	0.0	0.00
Non Stick/Support Ribs	PP-I G PA6 K	50.8	2.00	K600	152.8	6.02	15.0	0.59
Non Stick/Support Ribs	PP-I W G 04 K	76.2	3.00	K600	152.8	6.02	0.0	0.00
Non Stick/Support Ribs	PP-I W G	76.2	3.00	K600	152.8	6.02	15.0	0.59

Other Non Standard material and color: See uni Material and Color Overview.

Accessories

Side Guard

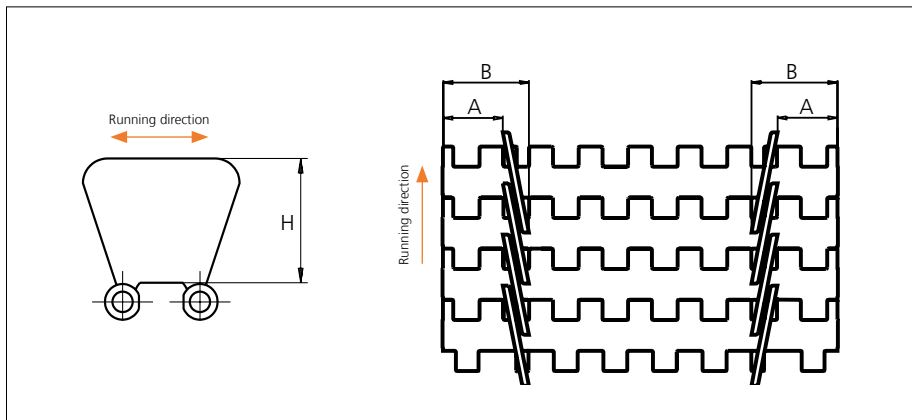

Type	Side Guard Material & color	H		A		B	
		mm	in	mm	in	mm	in
Closed	PP-I W G	31.4	1.24	15.0	0.59	25.0	0.98

Non Standard material and color: See uni Material and Color Overview.

Accessories

Tab

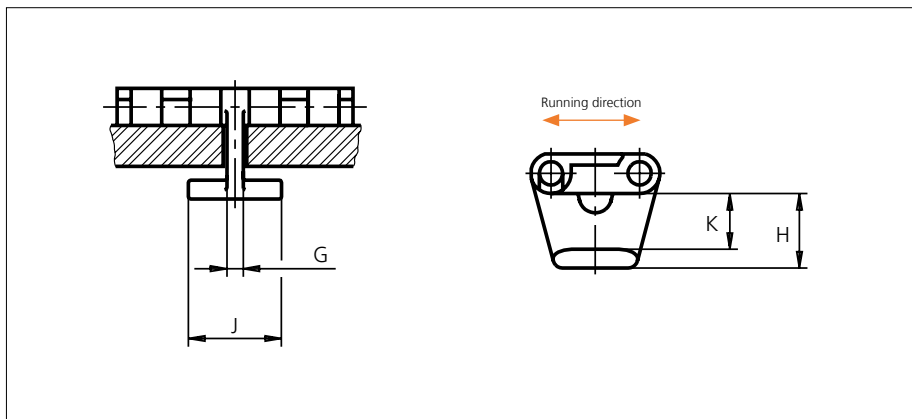

Type	Tab Material & color	G		J		K		H	
		mm	in	mm	in	mm	in	mm	in
Bottom Hold Down	POM-D W	3.5	0.14	20.0	0.79	11.7	0.46	15.9	0.63

Non Standard material and color: See uni Material and Color Overview.

Any questions? Please contact us.

Sprocket

No of teeth	Bore size													Overall diameter		Pitch diameter		Hub diameter		A-dimension		B-dimension		Single row/Two way	Double row/Two way	Molded PA6 LG	Machined PA6
	Pilot bore		0.75	0.78	0.98	1.00	1.18	1.25	1.50	1.57	2.36	2.50	3.54														
	mm	in	19.1	20.0	25.0	25.4	30.0	31.8	38.1	40.0	60.0	63.5	90.0	mm	in	mm	in	mm	in	mm	in	x	x	x	x		
Z07	x		●	●									42.6	1.68	43.9	1.73	30.0	1.18	15.4	0.61	26.3	1.04	x		x		
Z10	x					●	●						61.7	2.43	61.6	2.43	45.0	1.77	25.0	0.98	35.2	1.39	x		x		
Z17	x				●	●	●	●	■	■			105.0	4.13	103.7	4.08	65.0	2.56	46.6	1.83	56.2	2.21	x		x		
Z24	x					●	●	●	■	■	●		147.2	5.80	146.0	5.75	70.0	2.76	68.0	2.68	77.3	3.04	x		x		
Z25	x						●	●	●	●	■	■	153.3	6.04	152.0	5.98	70.0	2.76	71.0	2.80	80.3	3.16	x		x		

■ Molded sprocket

● Molded sprocket

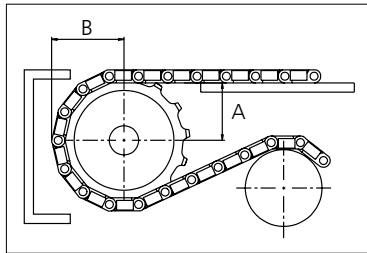
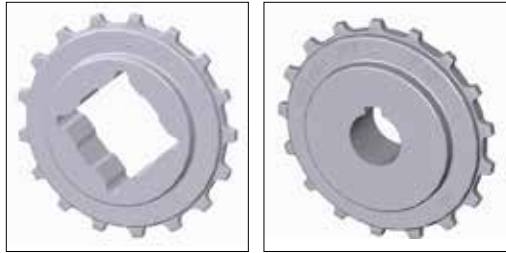

Other sprocket sizes are available upon request
 Two-part sprocket are available upon request
 Other bore sizes are available upon request
 uni Retainer Rings: See uni Retainer Ring data sheet
 Width of tooth = 4.8 mm (0.19 in)
 Width of sprocket = 25.0 mm (0.98 in)

Max load per sprocket shown does not take bore size into account.
 Please also ensure that sufficient size shaft is chosen for corresponding load.

For correct sprocket position: See uni Assembly Instructions for uni Light.
 For more detailed sprocket information, contact Customer Service.

Non standard material and color: See uni Material and Color Overview.

Any questions? Please contact us.

Morskate Aandrijvingen BV
 Oosterveldsingel 47A
 7558 PJ Hengelo (Ov)
 The Netherlands

NL
 T +31 (0)74 - 760 11 11
 info@morskateaanrijvingen.nl
 www.morskateaanrijvingen.nl

DE
 T +49 692 - 222 34 95
 info@morskateantriebstechnik.de
 www.morskateantriebstechnik.de

EN
 T +31 (0)74 - 760 11 11
 info@morskatedrivetechnology.com
 www.morskatedrivetechnology.com