

CODICE - CODE	DIMENSIONE BASE BASE DIMENSION	H		D1	F	CARICO STATICO STATIC LOAD NEWTON
19100Z	M30X2	110	24	27	17	70000
19100F	M30X2	110	24	27	17	70000
19101Z	M36X2	110	27	33	17	90000
19101F	M36X2	110	27	33	17	90000

▪ Material: galvanized steel. Application: machine tools, machine beds a.s.o.

“Z” CODE = surface finishing: zinc

“F” CODE = surface finishing: phosphated

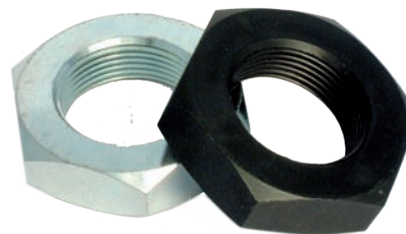
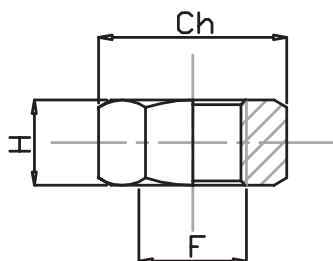

CODICE - CODE		F	CH	H
ZINCATA	FOSFATATA			
DD24X2Z	DD24X2F	M24x2	36	18
DD27X2Z	DD27X2F	M27x2	41	12
DD30X2Z	DD30X2F	M30x2	36	11
DD35X2Z	DD35X2F	M35x2	55	15
DD36X2Z	DD36X2F	M36x2	55	15
DD36X3Z	DD36X3F	M36x3	55	15
DD42X2Z	DD42X2F	M42x2	65	20

▪ Material: galvanized steel. Application: machine tools, machine beds a.s.o.

Any questions? Please contact us.

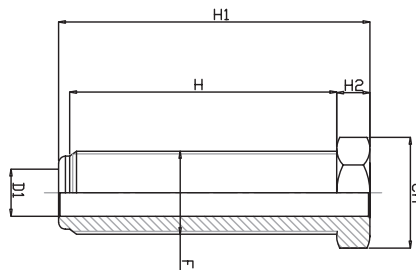

CODICE - CODE		DESCRIZIONE DESCRIPTION	H1	H2	H		D1	F	CARICO STATICO STATIC LOAD NEWTON
ZINCATA	FOSFATATA								
19110Z	19110F	VITE M36x3	135	15	116	41	22	36x3	90000

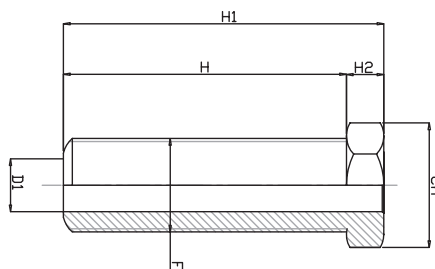

CODICE - CODE		DESCRIZIONE DESCRIPTION	H1	H2	H		D1	F	CARICO STATICO STATIC LOAD NEWTON
ZINCATA	FOSFATATA								
19111Z	19111F	VITE M42x2	140	20	120	45	27	42x2	100000

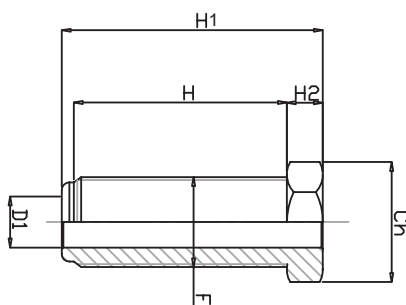

CODICE - CODE		DESCRIZIONE DESCRIPTION	H1	H2	H		D1	F	CARICO STATICO STATIC LOAD NEWTON
ZINCATA	FOSFATATA								
19112Z	19112F	VITE M30x2	87	12	70	36	17	30x2	70000

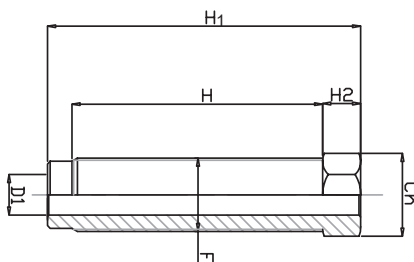

CODICE - CODE		DESCRIZIONE DESCRIPTION	H1	H2	H		D1	F	CARICO STATICO STATIC LOAD NEWTON
ZINCATA	FOSFATATA								
19106z	19106F	VITE M27X2	90	12	70	27	15	27x2	65000
19107Z	19107F	VITE M27X2	110	12	91	27	15	27x2	65000
19108Z	19108F	VITE M27X2	125	12	106	27	15	27x2	65000
19109Z	19109F	VITE M27X2	145	12	126	27	15	27x2	65000

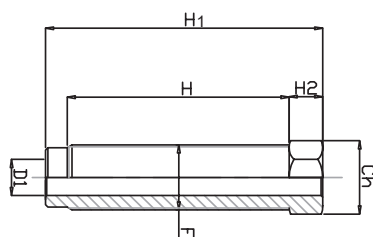

CODICE - CODE		DESCRIZIONE DESCRIPTION	H1	H2	H		D1	F	CARICO STATICO STATIC LOAD NEWTON
ZINCATA	FOSFATATA								
19080Z	19080F	VITE M24X2	105	15	85	24	13	24x2	60000
19090Z	19090F	VITE M24X2	160	15	136	24	13	24x2	60000
19102Z	19102F	VITE M35X2	120	15	95	41	22	35x2	90000
19103Z	19103F	VITE M35X2	195	15	170	41	22	35x2	90000
19104Z	19104F	VITE M36X2	120	15	95	41	22	36x2	90000
19105Z	19105F	VITE M36X2	195	15	170	41	22	36x2	90000